

Step 10

Place floor tray/liner inside the tent floor and secure to Velcro pieces of the tent cover.

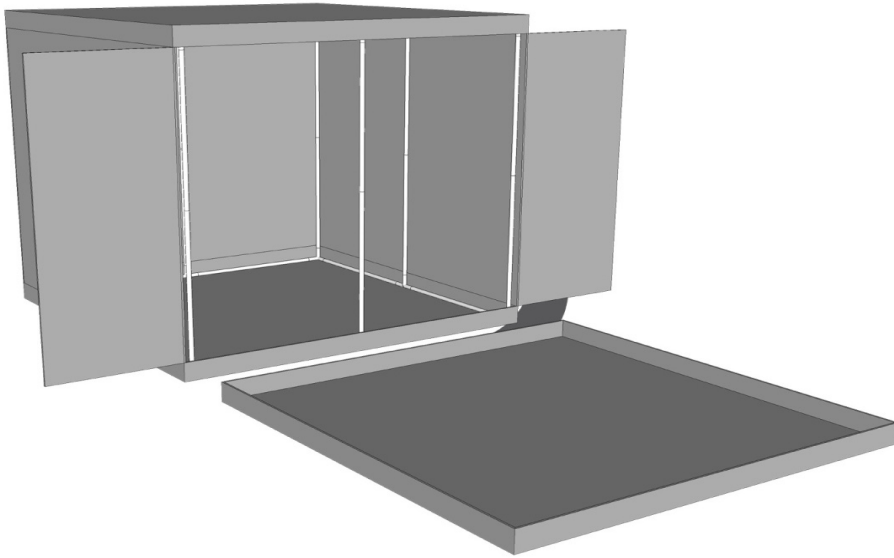

Step 11

Close all zippers. All parts have been assembled.

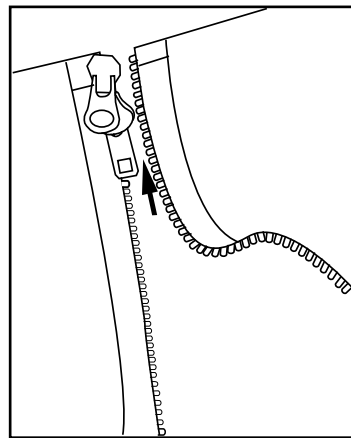
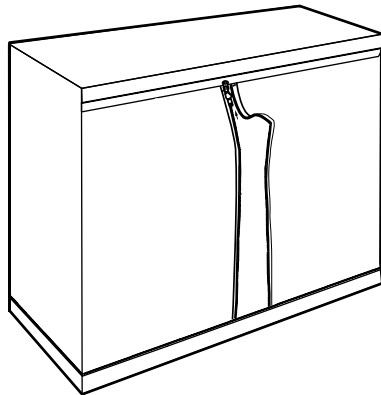

Grow tent ASSEMBLY INSTRUCTIONS

JR - 200200200

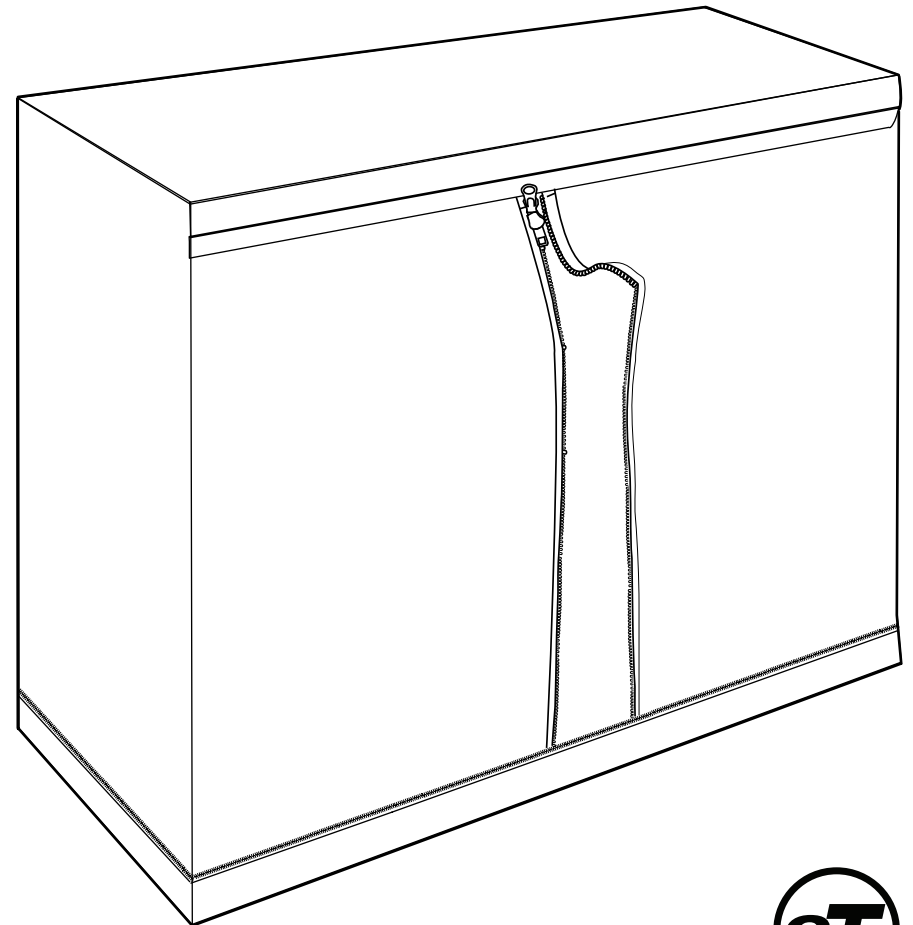

TENT SIZE: Length: 200cm - Width:200cm - Height: 200 cm





No tools required

Parts list

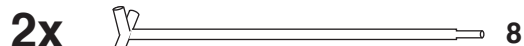
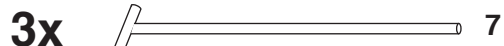
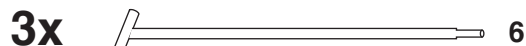
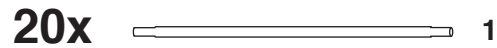
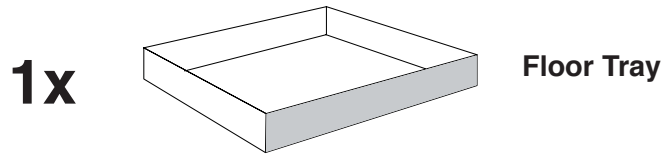
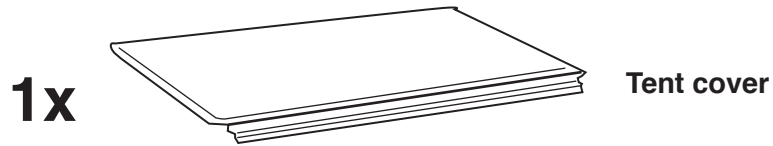

Step7

Gently pull up the back of the tent cover such that the two upper back corners of the cover are squarely in place. Note that having a helper makes this process easier.

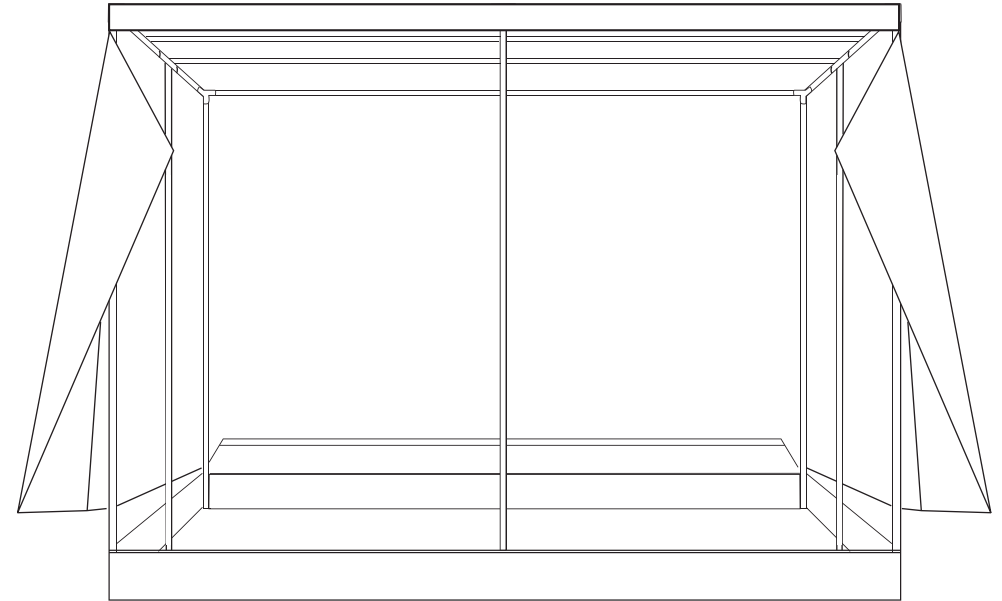

Step8

Gently pull the "roof" of the tent to cover the two upper front corners

Step9

Gently wriggle/adjust all eight corners until cover is square against the frame

Step3

Assemble remaining parts of the frame as shown below, once the frame is assembled, make sure that all the poles are fully inserted into the corners.

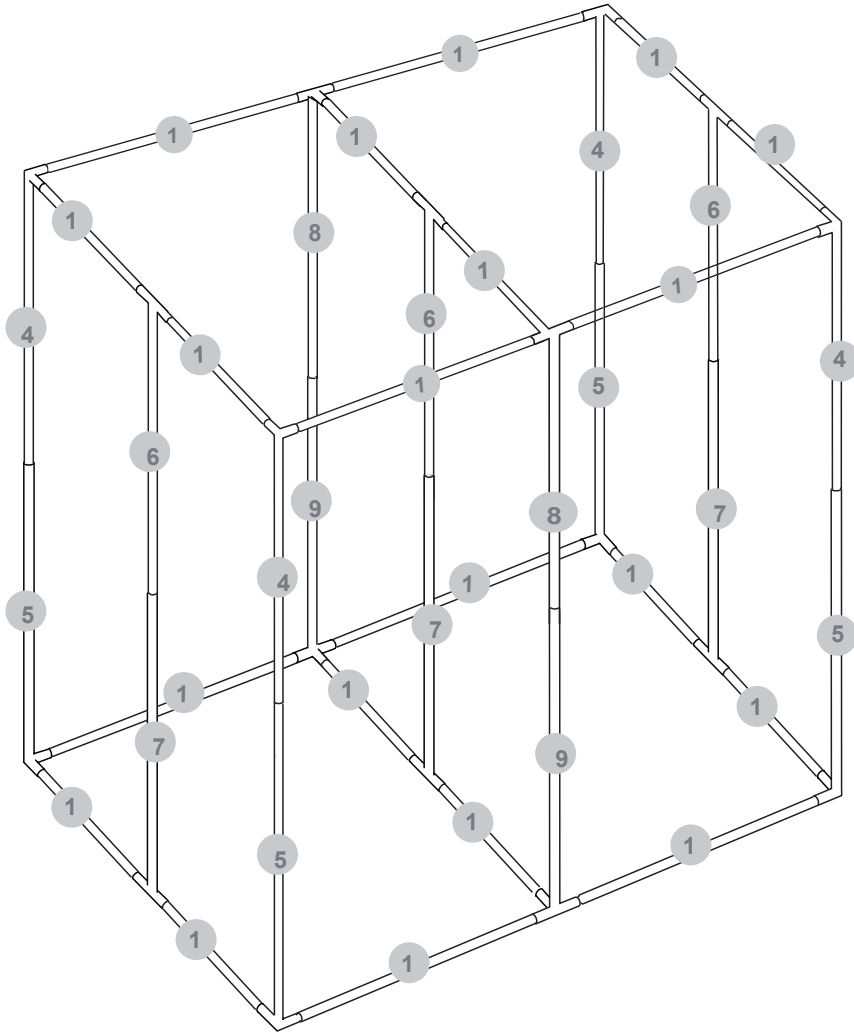

Step4

Place hanging poles 2 and 3 on top of the frame.

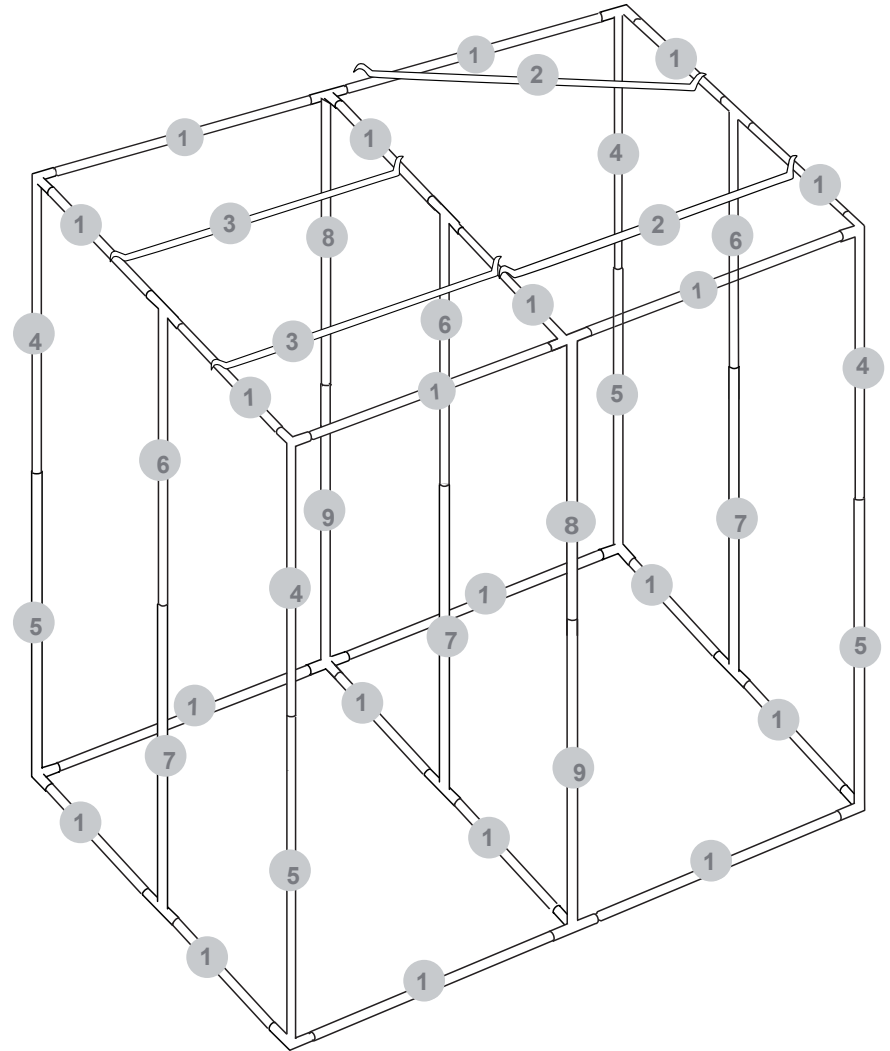

Step5

Unzip all zippers of the tent cover all the way.

Step6

Put frame upright on the base of the tent, making sure that all four corners are inside the base.

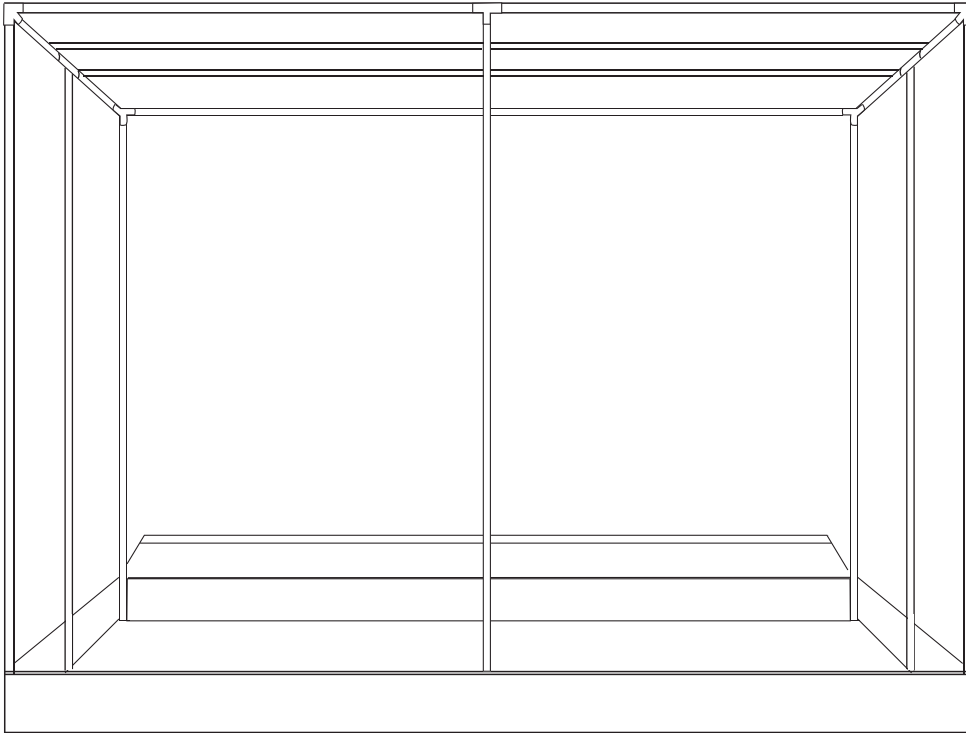

Step1

Assemble the bottom half of the frame as shown, making sure that the poles are fully inserted into the corner.

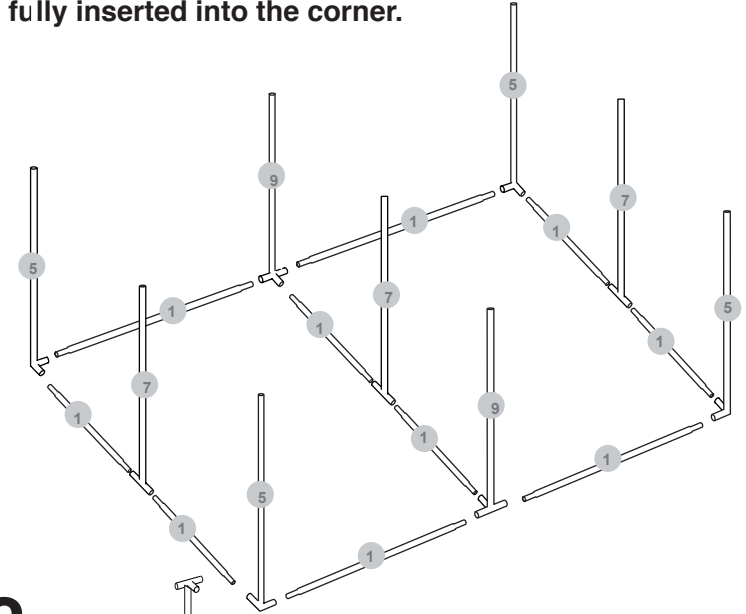

Step2

Connect poles as shown

