

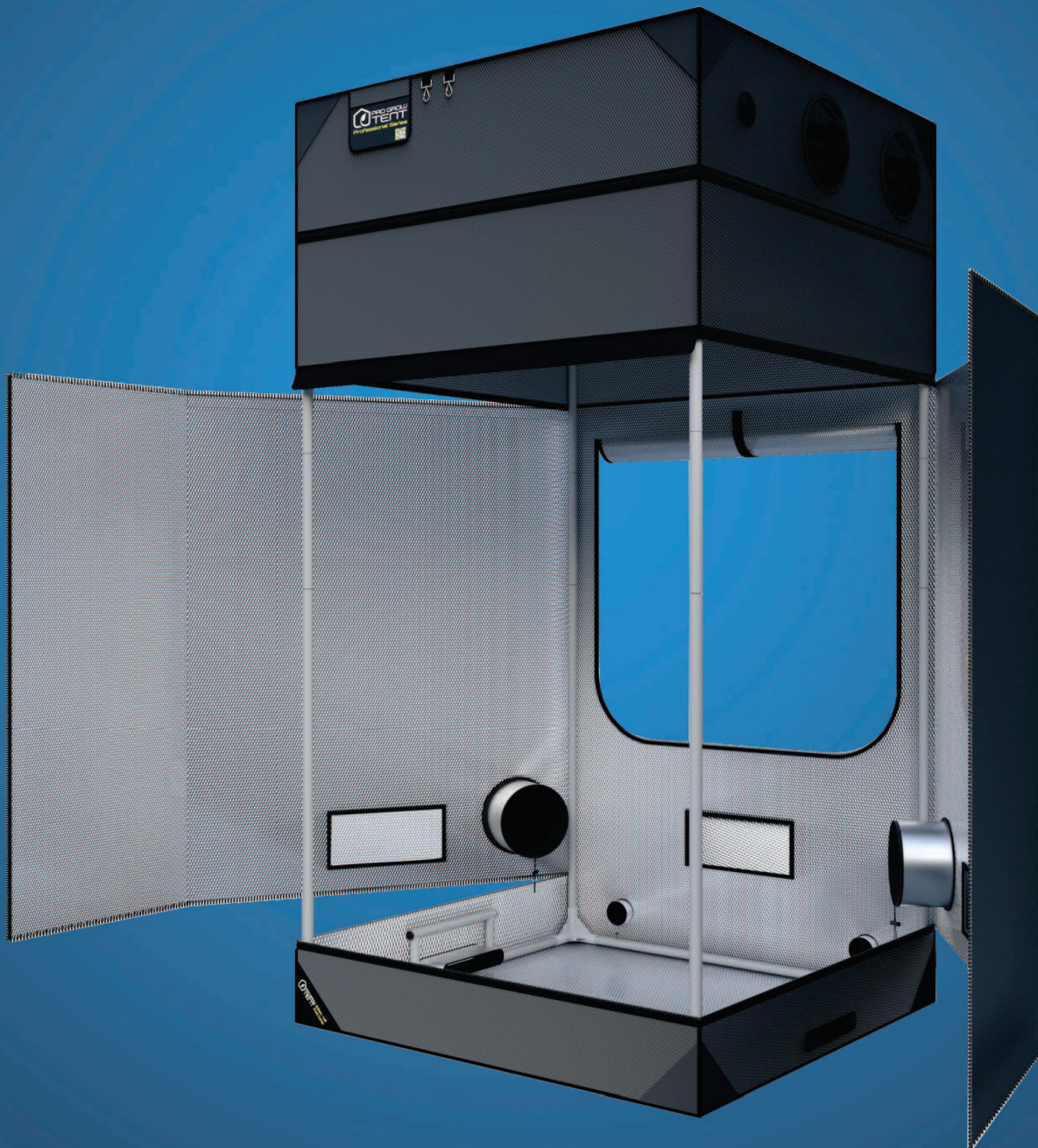

Assembly Instructions



- High Quality Grow Tent
- Tough ABS Plastic Fittings
- 25mm Powder Coated Poles
- 600 D Double Stitched Fabric
- Heavy Duty Industrial Zippers

PRO GROW TENT

Professional Series

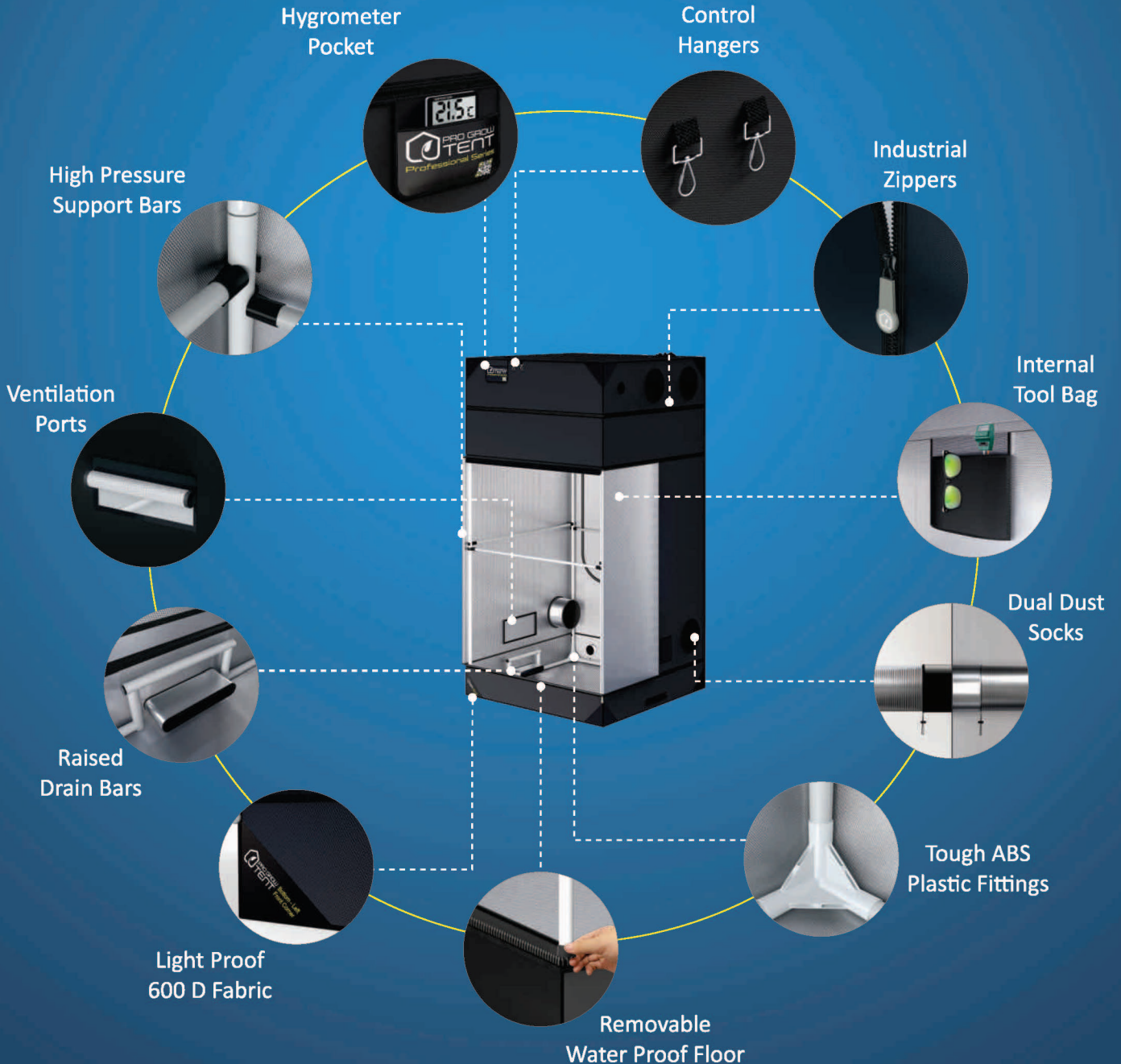
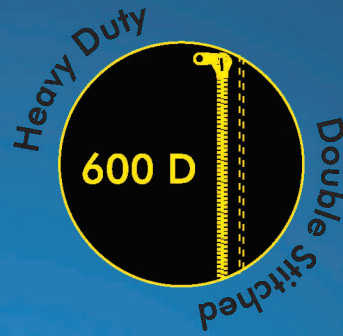
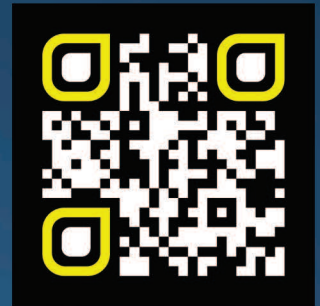



PRO GROW Tent is designed in Australia by Aussie growers to suit Australian conditions. Our team has over a hundred years of combined experience in the hydroponics industry.

Our range covers the most popular tent sizes from propagation to flowering, in one high quality series.

PRO GROW Tent offers industry leading performance, superior weight holding and a long service life.

PRO GROW Tent feature over-engineered white powder coated poles, with high strength ABS plastic corners. Heavy duty industrial zippers professionally sewn into double stitched light proof 600D Mylar fabric.

Removable waterproof flooring with a raised drain bar allows plumbing to lay flat on the floor for complete drainage. High pressure support bars to handle the highest pressure fans & filters. Multiple dual drawstring socks for electrical equipment and ducting, positioned where you need them.

Other key features include insect proof ventilation ports, external gear hangers and an internal tool bag.

The larger tents feature an extendable roof panel allowing to grow at 2.0 m or 2.3 m high, perfect for most internal ceiling heights. Grow like the professionals with PRO GROW.



Assembly Instructions

0.7 W x 0.45 L x 0.7m H

Clone Tent



- High Quality Grow Tent
- Tough ABS Plastic Fittings
- 16mm Powder Coated Poles
- 600 D Double Stitched Fabric
- Heavy Duty Industrial Zippers

PRO GROW TENT

Professional Series



Assembly Instructions

| Tent size (cm) | Tube 1 | Tube 2 | Tube 3 | Tube 4 | Tube 5 | Tube 6 | Tube 7 |
|----------------|--------|--------|--------|--------|--------|--------|--------|
| 70x45x70 cm | x4 | x4 | x4 | / | / | x1 | / |



x8

- 1 x4
- 2 x4
- 3 x4
- 6 x1

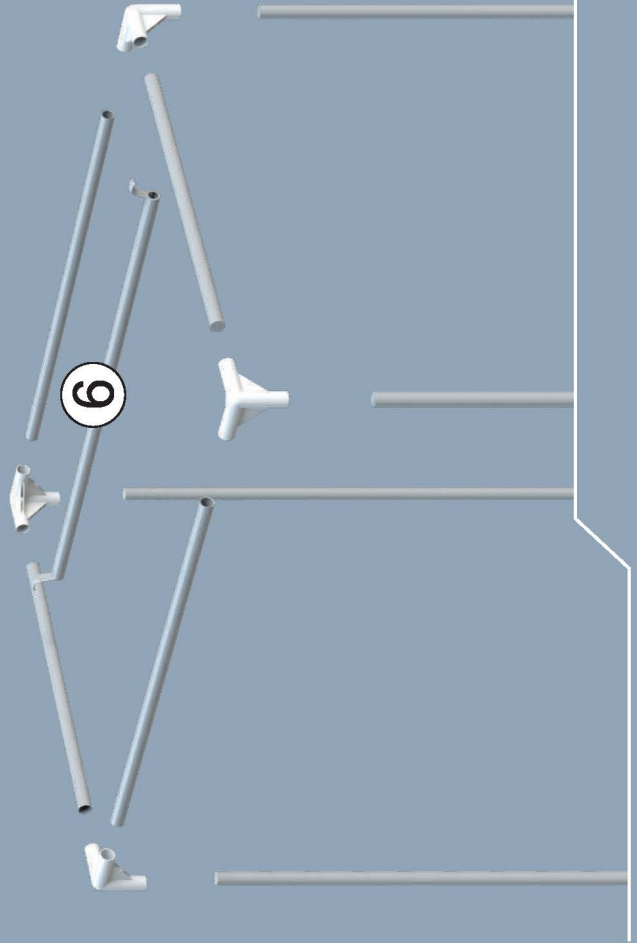
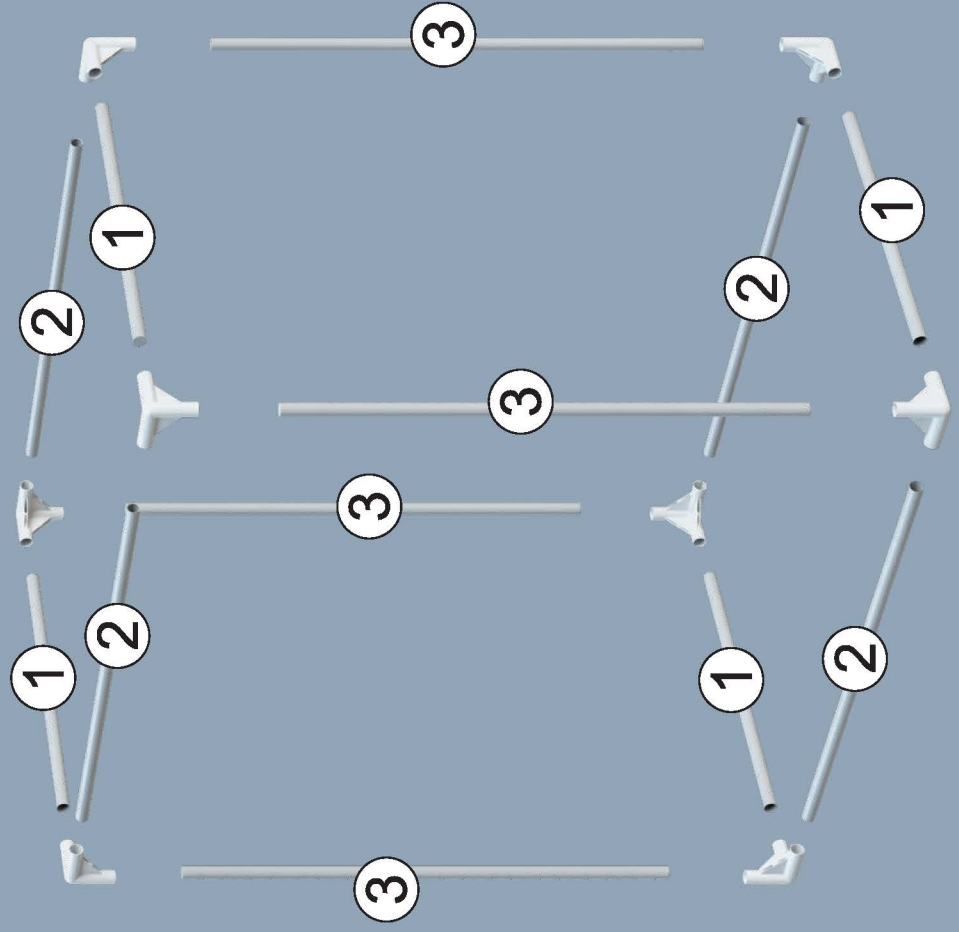

1

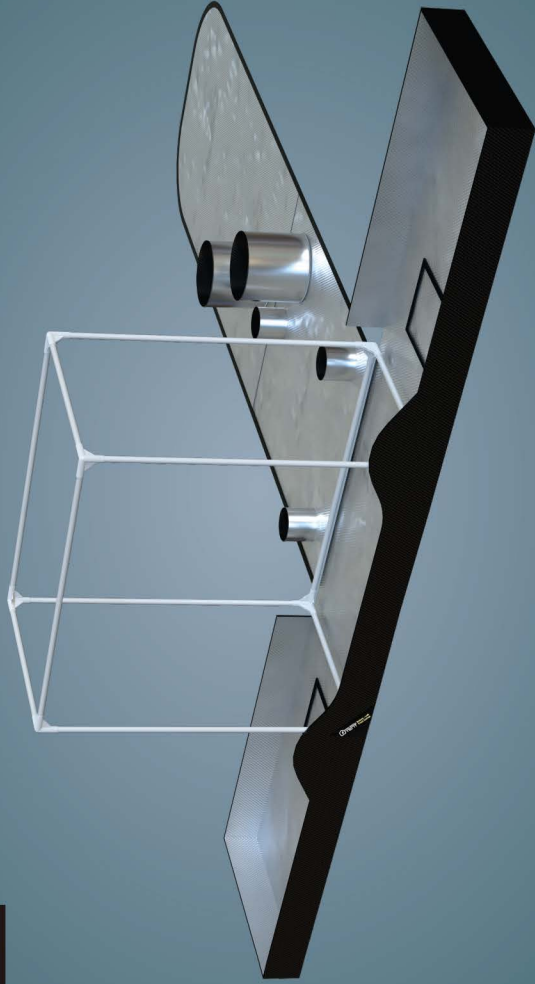

3



PROLOGUE TENT
Bottom - Left
Front Corner

2

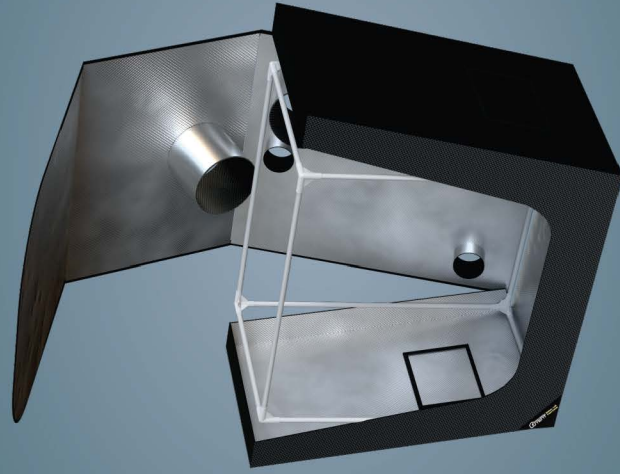

1. Unfold the tent and locate the bottom - left front corner tag for orientation. Place the assembled frame onto the tent base as pictured.
2. Lift the tent sides up and fit over the top sides of the frame.
3. Lift the back of the tent up and over the frame then zip the top and sides together.

Pair Your Tent With PRO GROW LEDs

0.7 W x 0.45 L

Use with

PRO GROW
LED - MODEL X

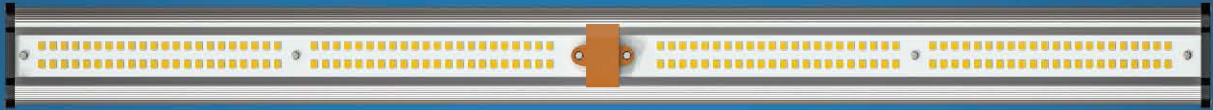

60 W - 1 BAR

140 $\mu\text{mol/s}$



700 mm

450 mm

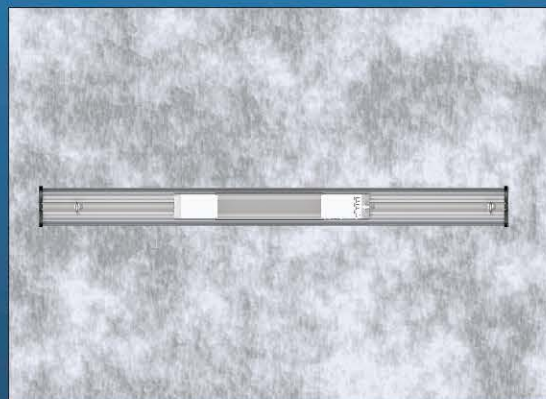

www.progrow.net.au

 **PRO GROW
TENT**
Professional Series

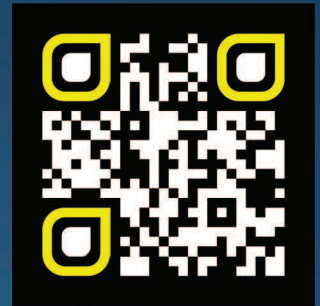

Assembly Instructions

1.0 W x 1.0 L x 2.0 m H



- High Quality Grow Tent
- Tough ABS Plastic Fittings
- 25mm Powder Coated Poles
- 600 D Double Stitched Fabric
- Heavy Duty Industrial Zippers

www.progrow.net.au

PRO GROW TENT

Professional Series



Assembly Instructions

| Tent size (cm) | Tube 1 | Tube 2 | Tube 3 | Tube 4 | Tube 5 | Tube 6 | Tube 7 |
|----------------|--------|--------|--------|--------|--------|--------|--------|
| 100x100x200 cm | x6 | x2 | x4 | x4 | x1 | x2 | / |

① x6

② x2

③ x4

④ x4

⑤ x1

⑥ x2

⑧ x4 High Pressure Support Bars

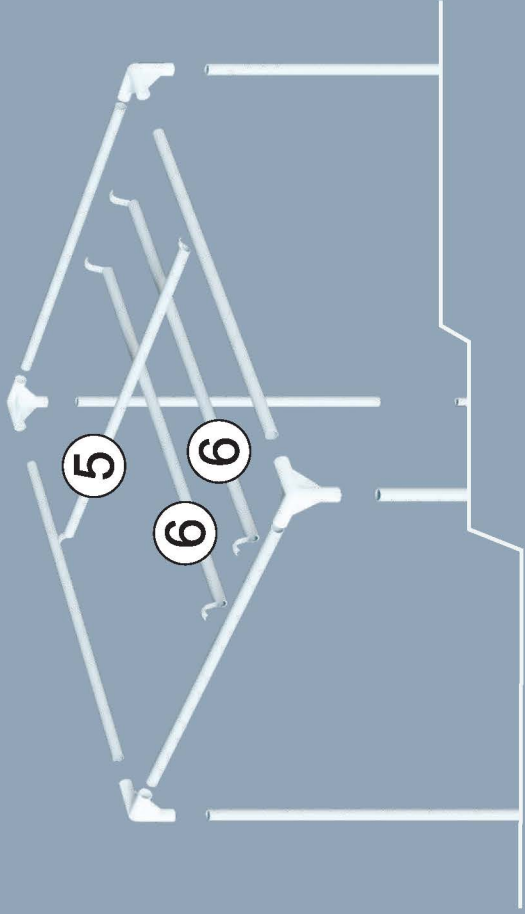
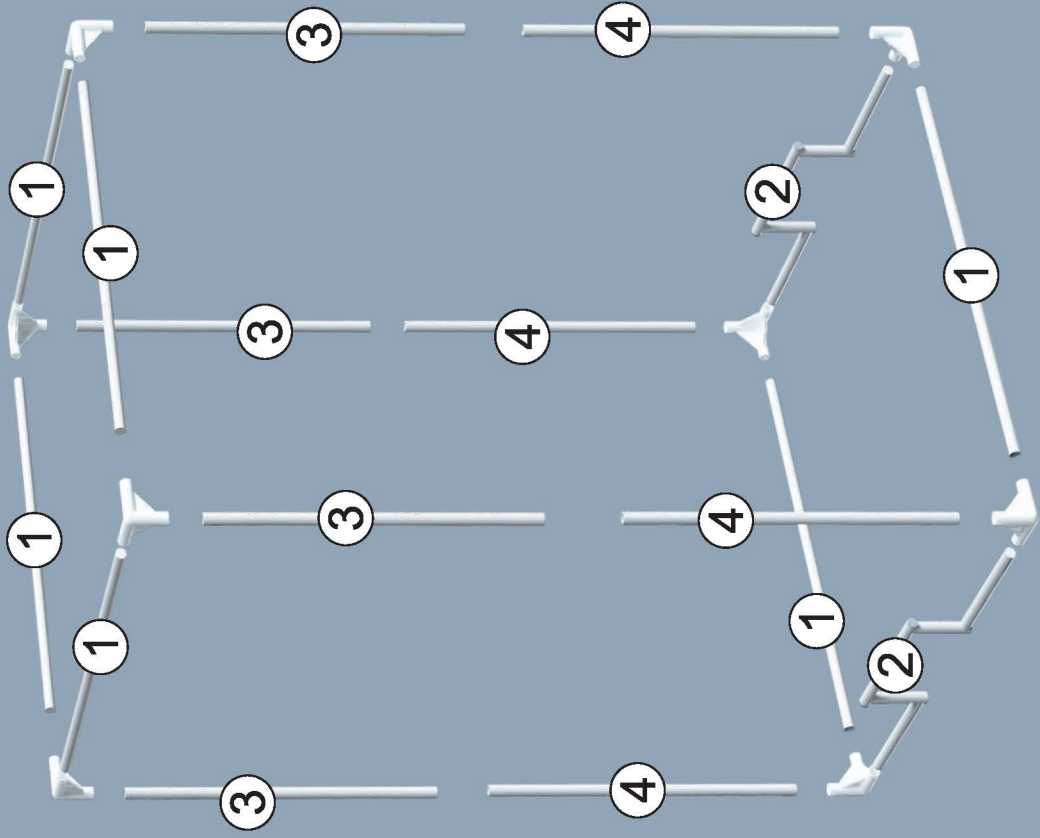

1

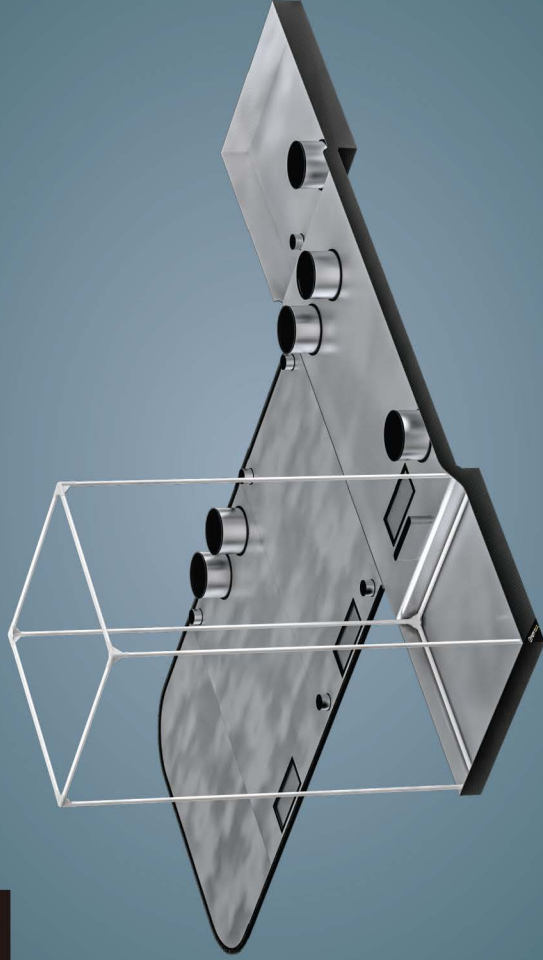

3

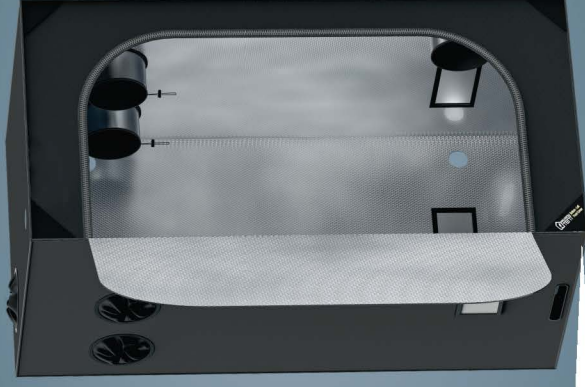

PROGRESSIVE
TENT
Bottom - Left
Front Corner

2

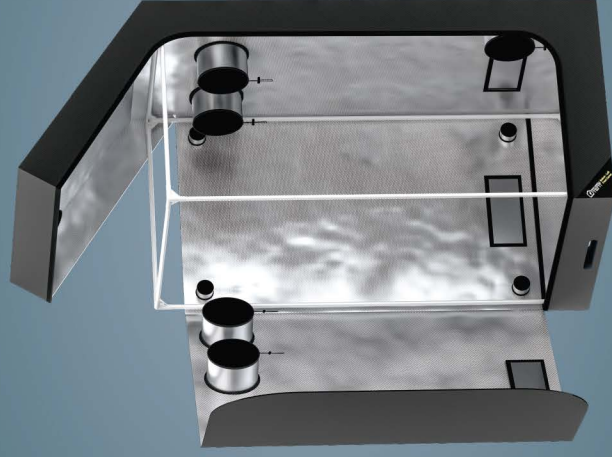

1. Unfold the tent and locate the bottom - left front corner tag for orientation. Place the assembled frame onto the tent base as pictured.
2. Lift the tent sides up and fit over the top sides of the frame.
3. Lift the back of the tent up and over the frame then zip the top and sides together.
4. Install the high pressure support poles.

Pair Your Tent With PRO GROW LEDs

1.0 W x 1.0 L

Use with

PRO GROW

300 W - UFO LED



300 W - UFO LED

620 $\mu\text{mol/s}$



1000 mm

1000 mm

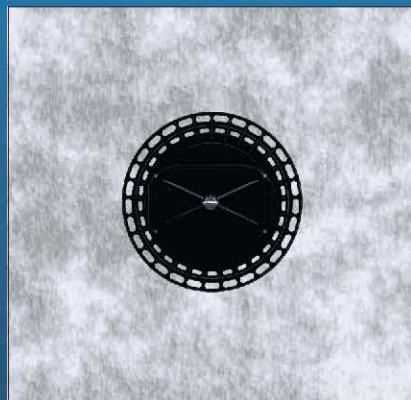

www.progrow.net.au



Assembly Instructions

1.2 W x 1.2 L x 2.0 **or** 2.3 m H
1.5 W x 1.5 L x 2.0 **or** 2.3 m H



- High Quality Grow Tent
- Tough ABS Plastic Fittings
- 25mm Powder Coated Poles
- 600 D Double Stitched Fabric
- Heavy Duty Industrial Zippers

Assembly Instructions

| Tent size (cm) | Tube 1 | Tube 2 | Tube 3 | Tube 4 | Tube 5 | Tube 6 | Tube 7 |
|--------------------|--------|--------|--------|--------|--------|--------|--------|
| 120x120x200 cm | x6 | x2 | x4 | x4 | x1 | x2 | / |
| 120x120x200/230 cm | x6 | x2 | x4 | x4 | x1 | x2 | x4 |
| 150x150x200 cm | x6 | x2 | x4 | x4 | x1 | x2 | / |
| 150x150x200/230 cm | x6 | x2 | x4 | x4 | x1 | x2 | x4 |

① x6

② x2

③ x4

④ x4

⑤ x1

⑥ x2

⑧ x4 High Pressure Support Bars



x8

Note: Tube 7 is only used with the 2.3m extension panel

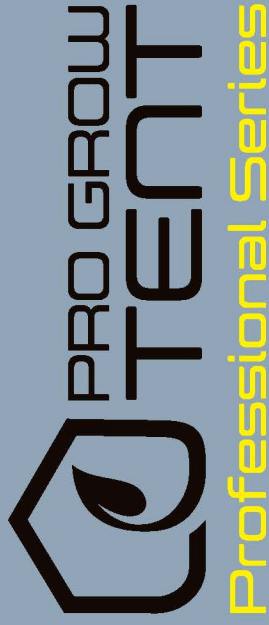
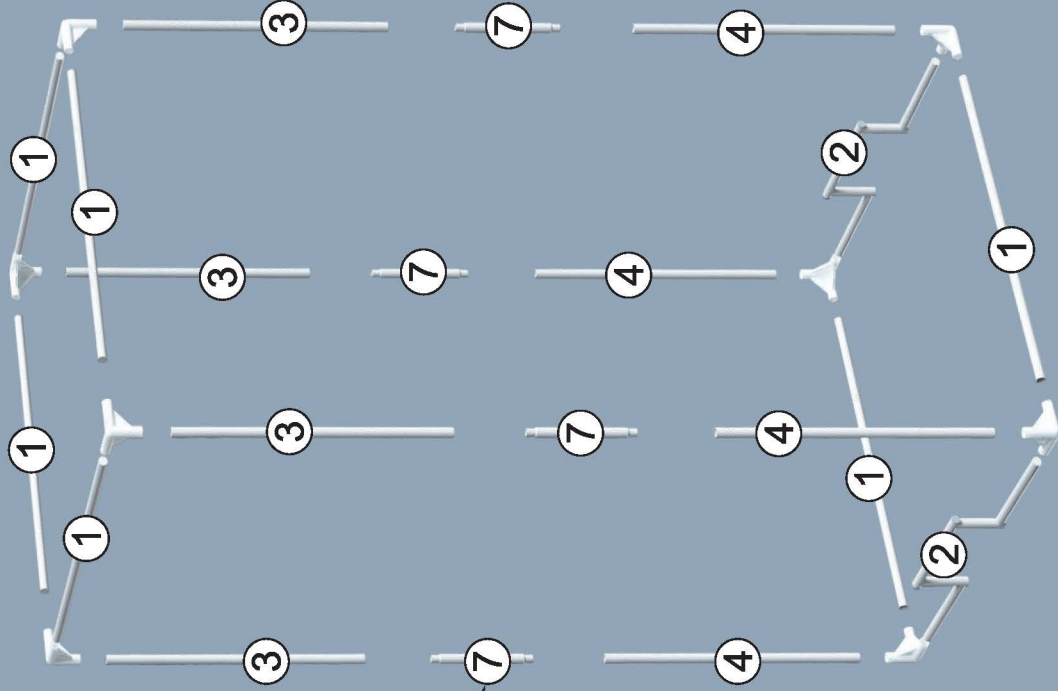
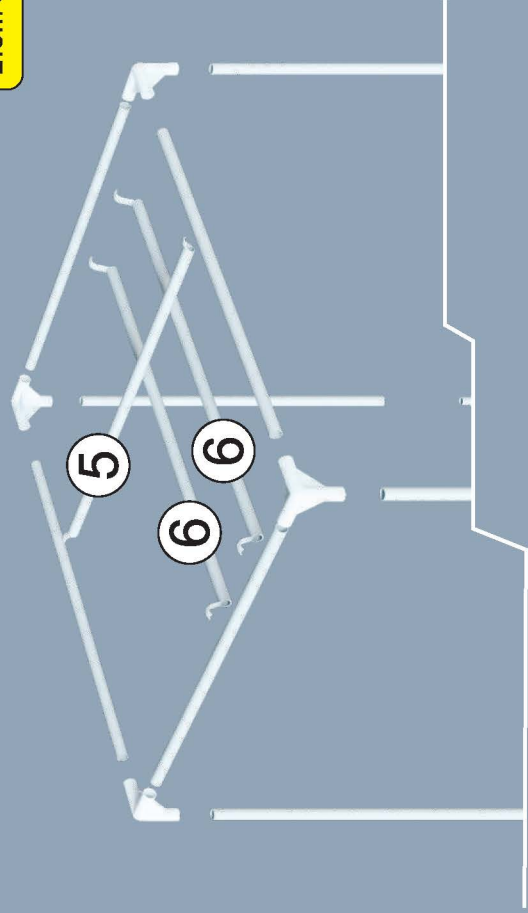

1

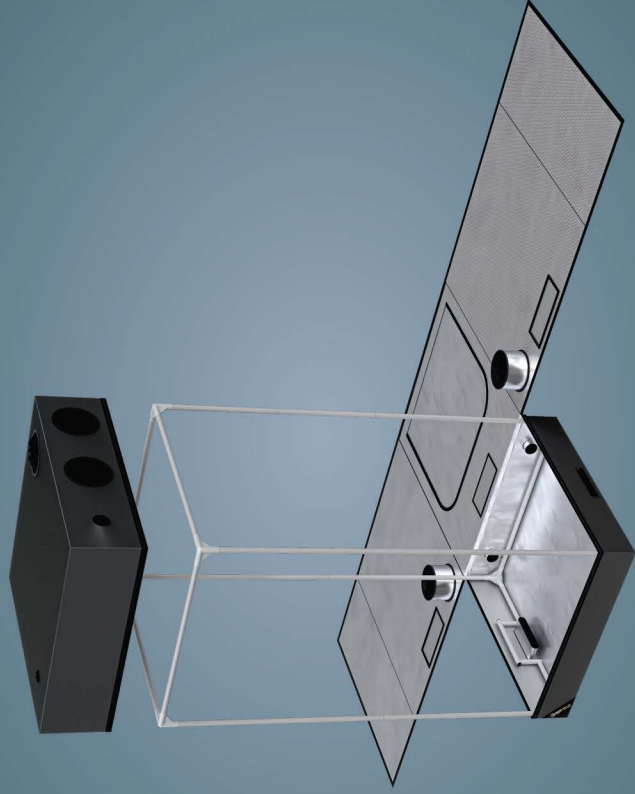

3

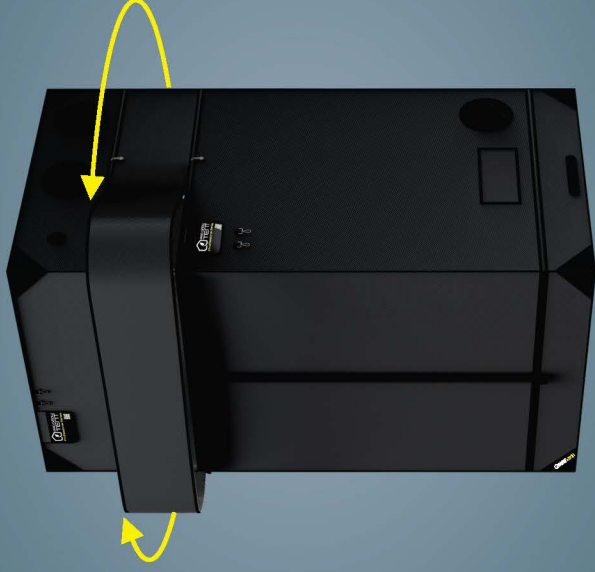

2



PRO GROW
TENT
Bottom - Left
Front Corner

1. Unfold the tent and locate the bottom - left front corner tag for orientation. Place the assembled frame onto the tent base as pictured.
2. Place the roof panel over the top sides of the frame. **Fit the extension panel if using at 2.3 metres high.**
3. Lift the back of the tent up and over the frame then zip the top and sides together.
4. Install the high pressure support poles.

Pair Your Tent With PRO GROW LEDs

1.2 W x 1.2 L

Use with

PRO GROW
500 W - UFO LED



500 W - UFO LED
1050 $\mu\text{mol/s}$



1200 mm

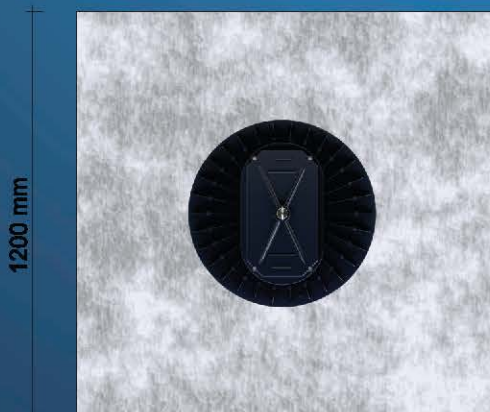

1200 mm

1.5 W x 1.5 L

Use with

PRO GROW
LED - MODEL S

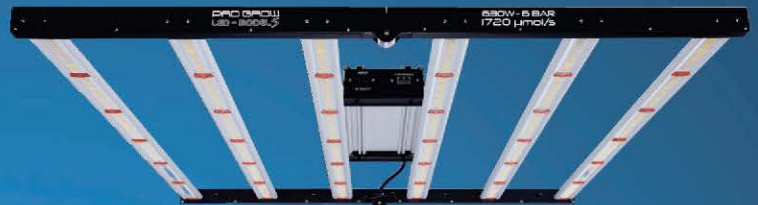

630 W - 6 BAR
1720 $\mu\text{mol/s}$



1500 mm

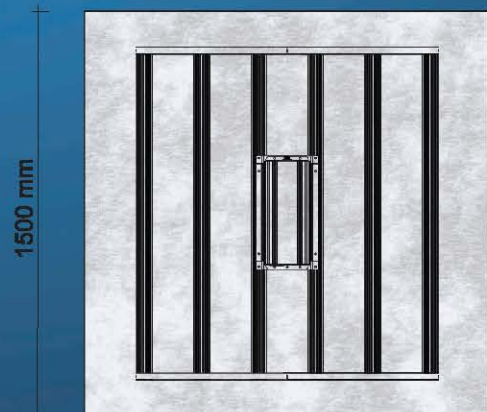

1500 mm

PRO GROW TENT

Professional Series



Assembly Instructions

1.2 W x 2.4 L x 2.0 or 2.3 m H
1.5 W x 3.0 L x 2.0 or 2.3 m H

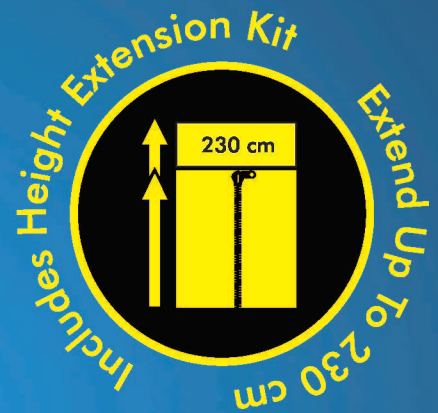





- High Quality Grow Tent
- Tough ABS Plastic Fittings
- 25mm Powder Coated Poles
- 600 D Double Stitched Fabric
- Heavy Duty Industrial Zippers

www.progrow.net.au

Assembly Instructions

| Tent size (cm) | Tube 1 | Tube 2 | Tube 3 | Tube 4 | Tube 5 | Tube 6 | Tube 7 |
|--------------------|--------|--------|--------|--------|--------|--------|--------|
| 240x120x200 cm | x12 | x2 | x6 | x6 | x2 | x4 | / |
| 240x120x200/230 cm | x12 | x2 | x6 | x6 | x2 | x4 | x6 |
| 300x150x200 cm | x12 | x2 | x6 | x6 | x2 | x4 | / |
| 300x150x200/230 cm | x12 | x2 | x6 | x6 | x2 | x4 | x6 |

- 1  x12
- 2  x2
- 3  x6
- 4  x6
- 5  x2
- 6  x4
- 8  x7 High Pressure Support Bars



Note: Tube 7 is only used with the 2.3m extension panel

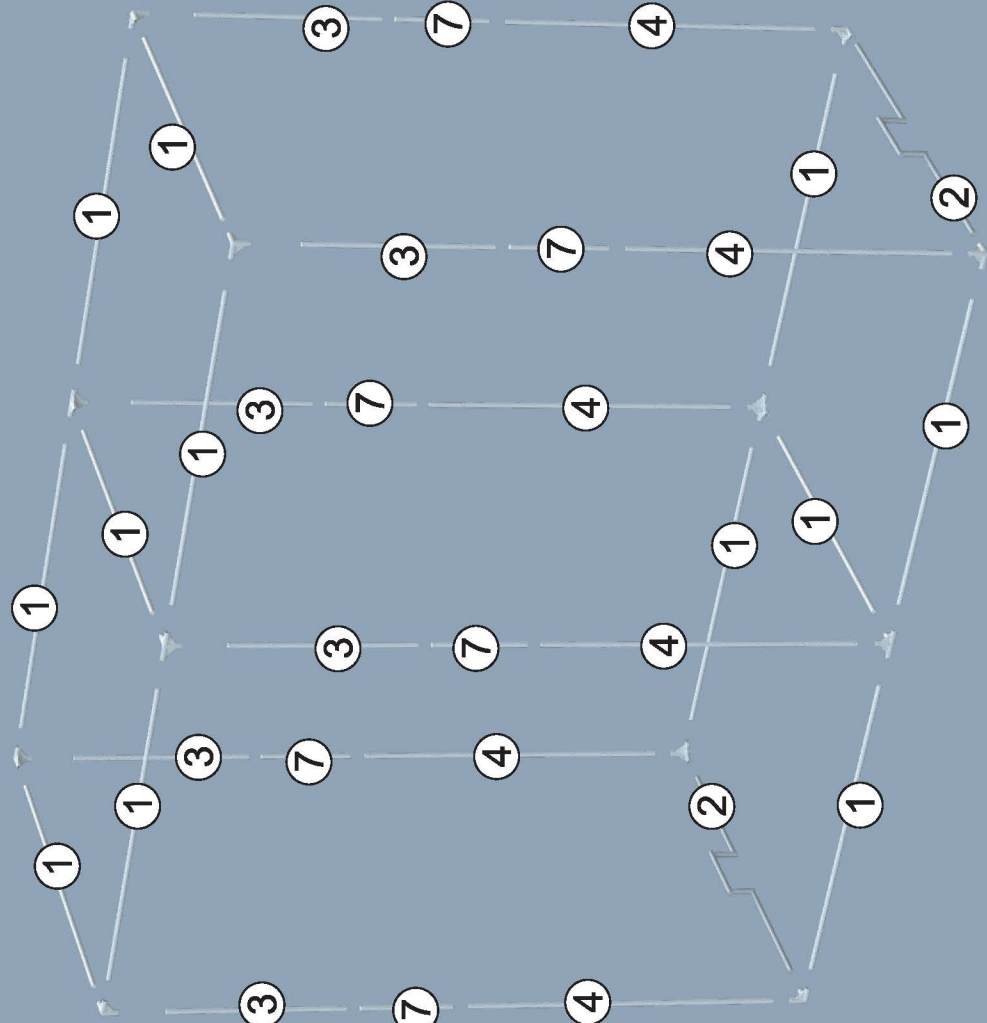
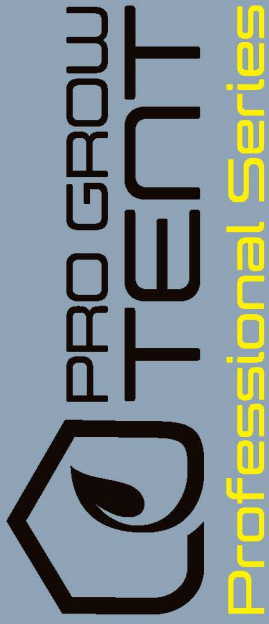

1

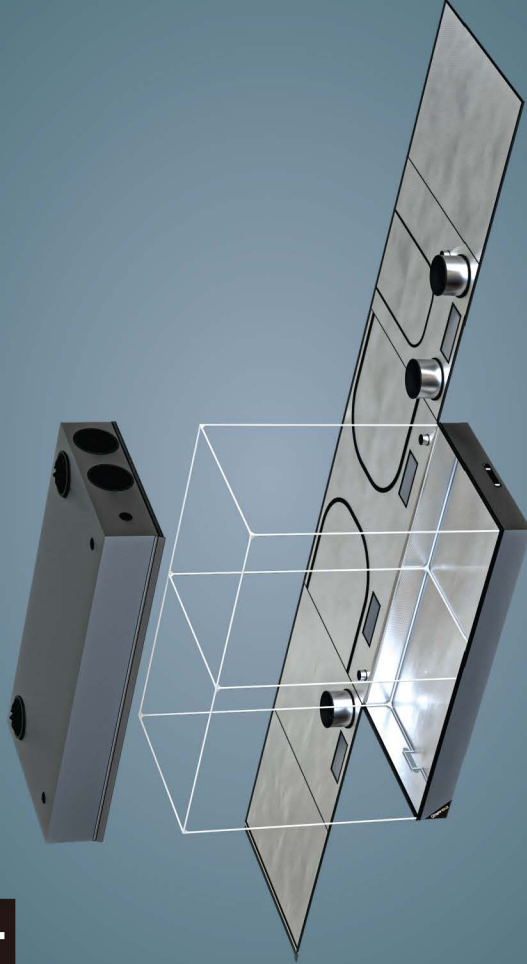

3



2

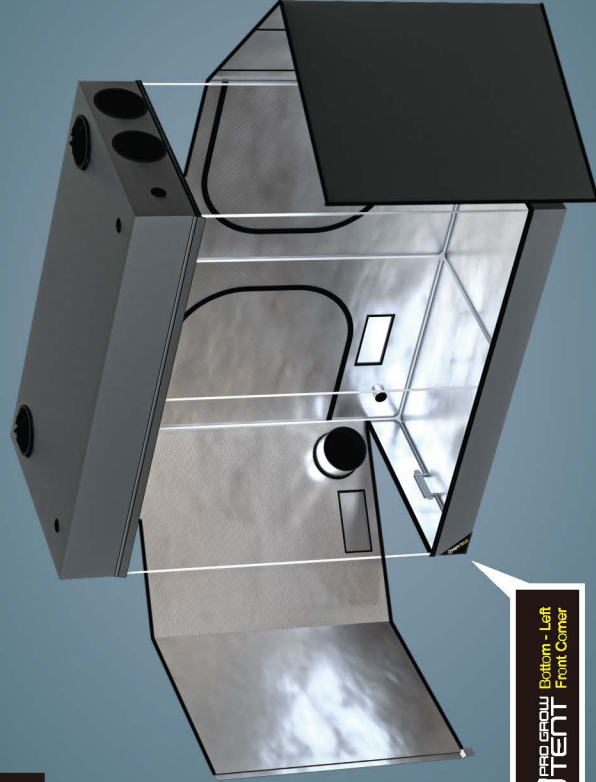

1. Unfold the tent and locate the bottom - left front corner tag for orientation. Place the assembled frame onto the tent base as pictured.
2. Place the roof panel over the top sides of the frame. **Fit the extension panel if using at 2.3 metres high.**
3. Lift the back of the tent up and over the frame then zip the top and sides together.
4. Install the high pressure support poles.

Pair Your Tent With PRO GROW LEDs

1.2 W x 2.4 L

Use with 2 x

PRO GROW
LED - MODEL S

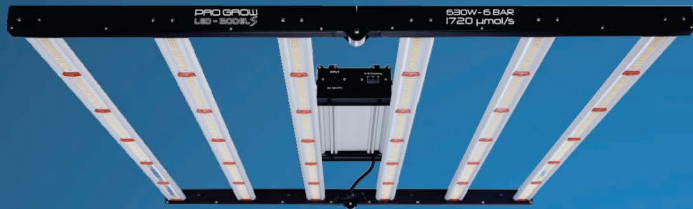

630 W - 6 BAR
1720 $\mu\text{mol/s}$

1.5 W x 3.0 L

Use with 2 x

PRO GROW
LED - MODEL Z



780 W - 8 BAR
1950 $\mu\text{mol/s}$



2400 mm

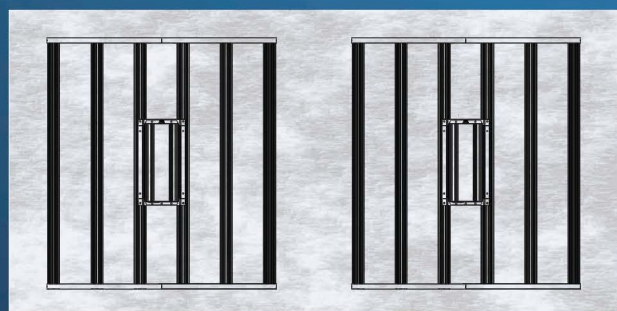

1200 mm



3000 mm

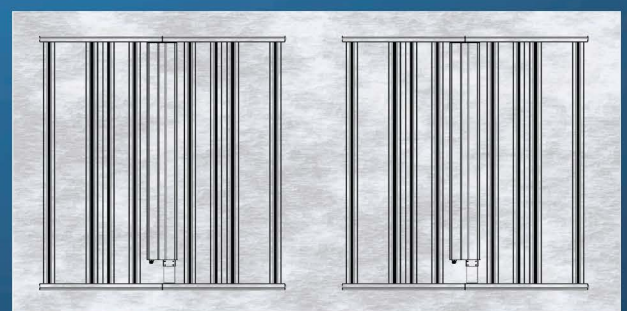

1500 mm

PRO GROW
TENT
Professional Series



0.45 W x 0.7 L x 0.7 m H
Actual Size: 455 x 705 x 705 mm



1.0 W x 1.0 L x 2.0 m H
Actual Size: 1005 x 1005 x 2005 mm



1.2 W x 1.2 L x 2.0 / 2.3 m H
Actual Size: 1205 x 1205 x 2005 / 2305 mm



1.2 W x 2.4 L x 2.0 / 2.3 m H
Actual Size: 1205 x 2405 x 2005 / 2305 mm



1.5 W x 1.5 L x 2.0 / 2.3 m H
Actual Size: 1505 x 1505 x 2005 / 2305 mm

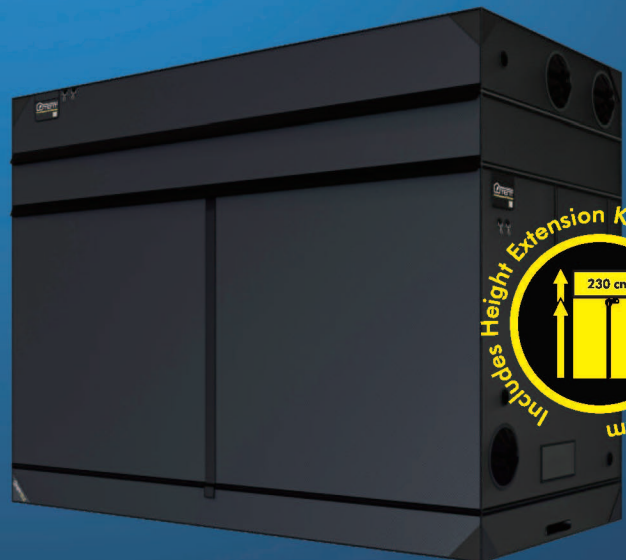

1.5 W x 3.0 L x 2.0 / 2.3 m H
Actual Size: 1505 x 3005 x 2005 / 2305 mm