

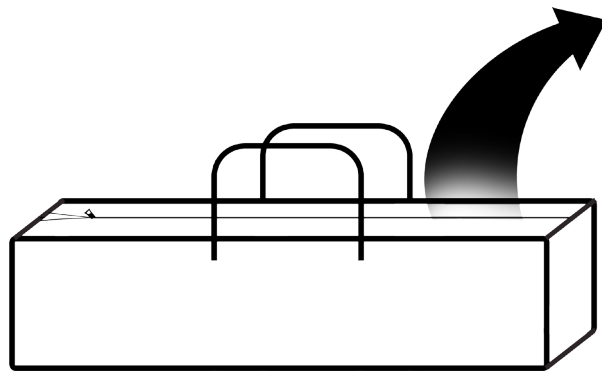

# Instructions

## 3x3 Gorilla Grow Tent

### 1. Unpack



### 2. Check

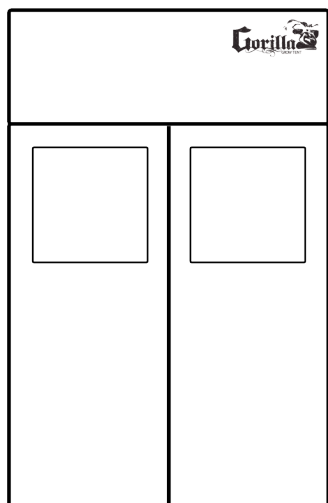

1x  
Tent

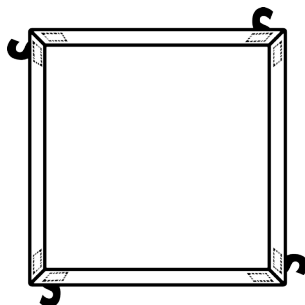

1x  
Spill Pool



1x  
Extension Skirt

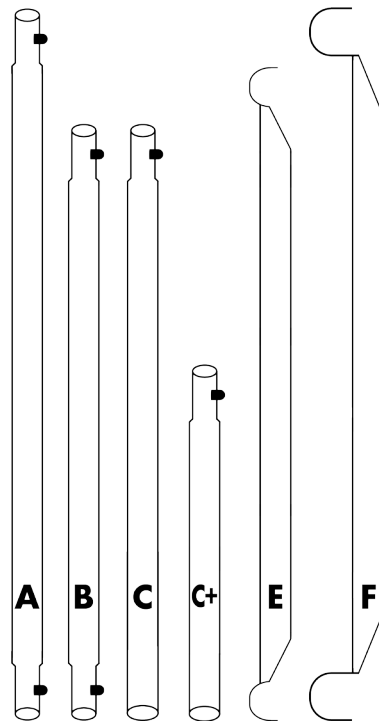

8x 4x 4x 4x 2x 2x  
Poles

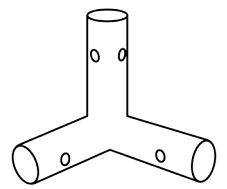

8x  
Corner Piece

# 3. Unfold

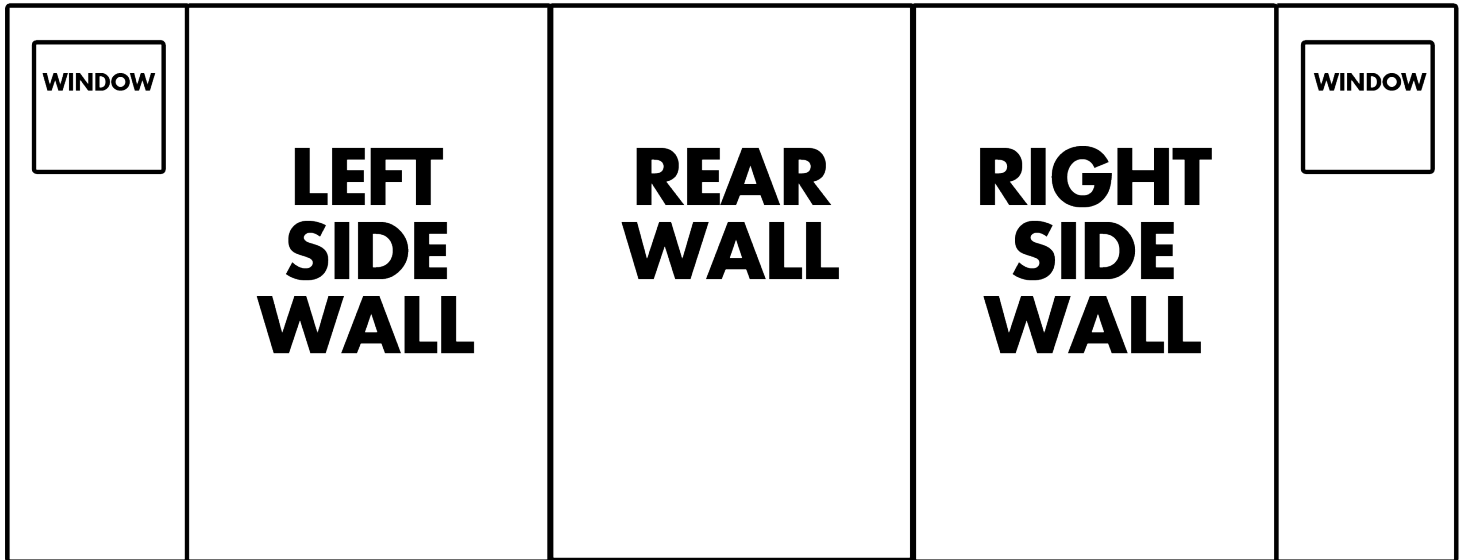
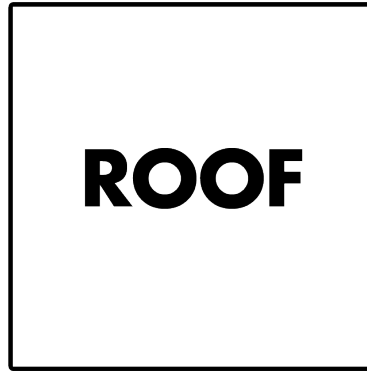

# 4. Assemble frame inside of tent floor beginning with frame base, and building upward

\*If you do not plan on using the height extension DO NOT add the C+ poles

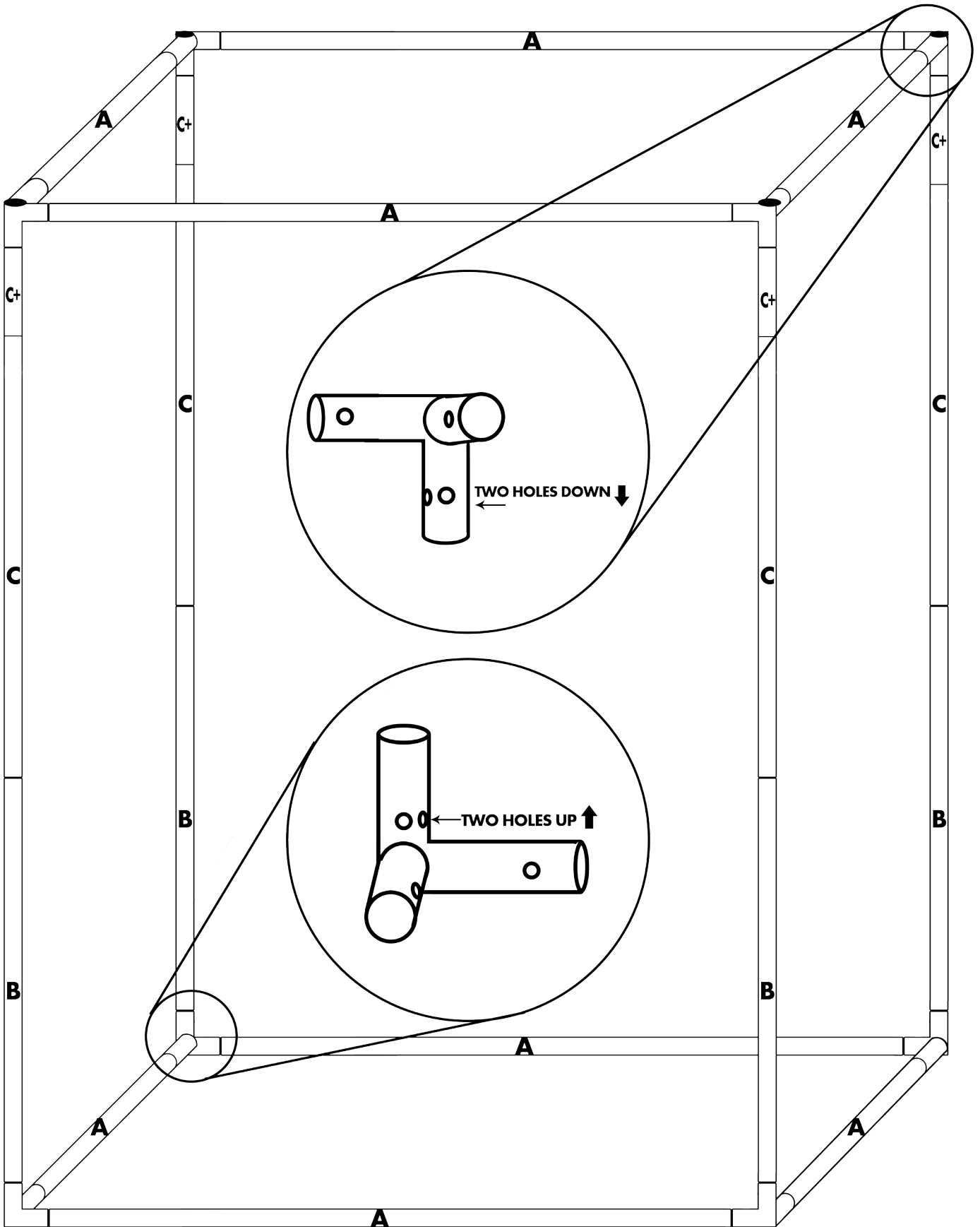

- 5.** Place roof onto tent frame.  
Carefully guide each corner of the roof over each corner of the frame a little at a time. This will allow plenty of slack to properly fit the corners. Do not fully seat the roof at one corner and attempt to stretch corners over frame. Do not use excessive force. Doing so may damage your tent and void warranty.

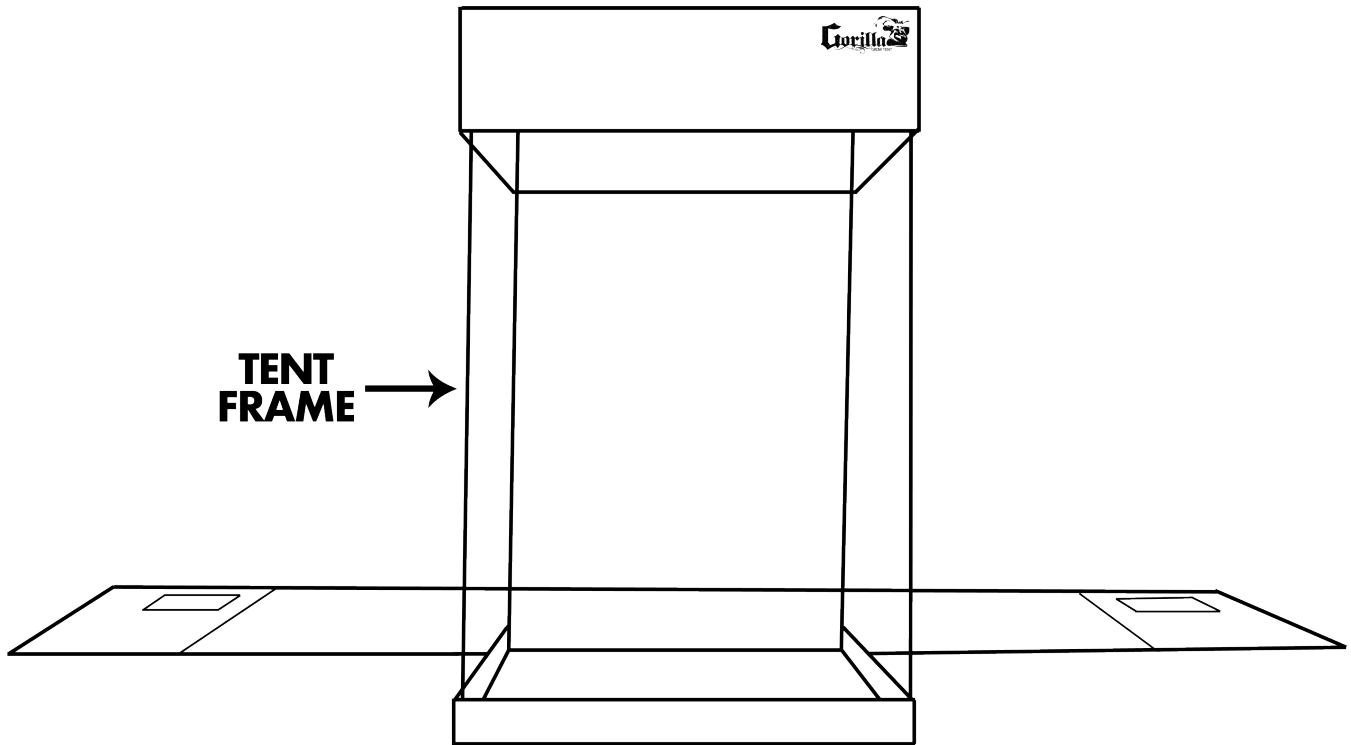

- 6.** Starting at the back of the tent add & zip extension skirt  
\* If you are not using the height extension, skip to step 7

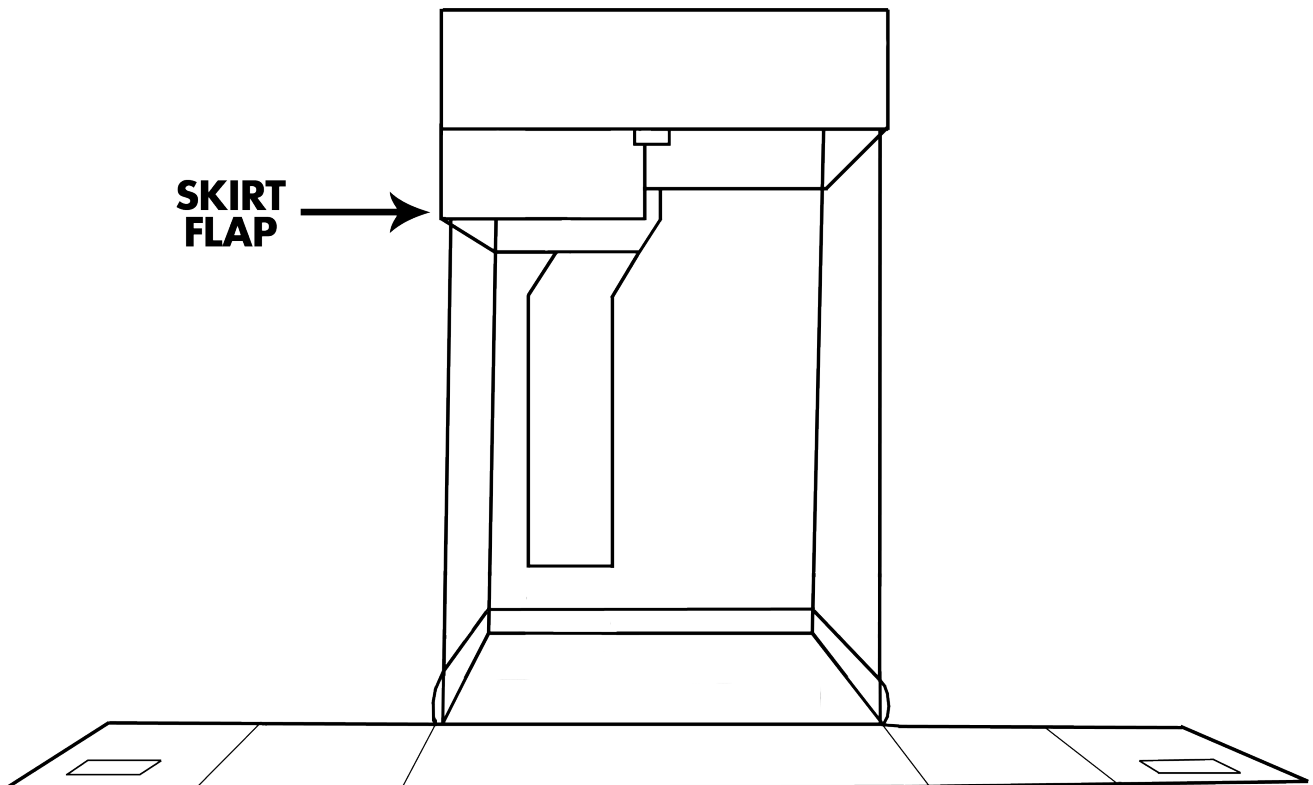

# Zipper Detail

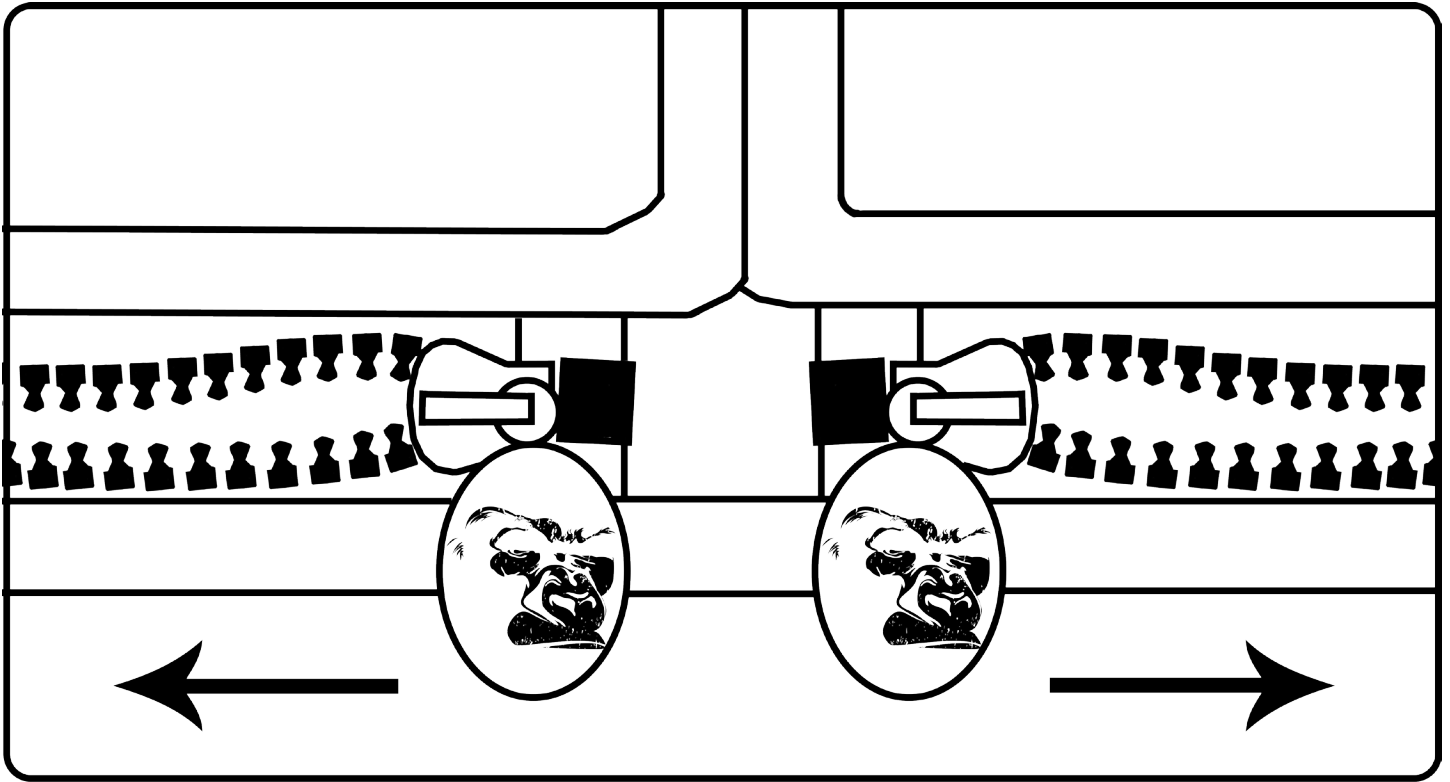

## 7. Bring Tent Body To Velcro Assist Strips & Zip Tent

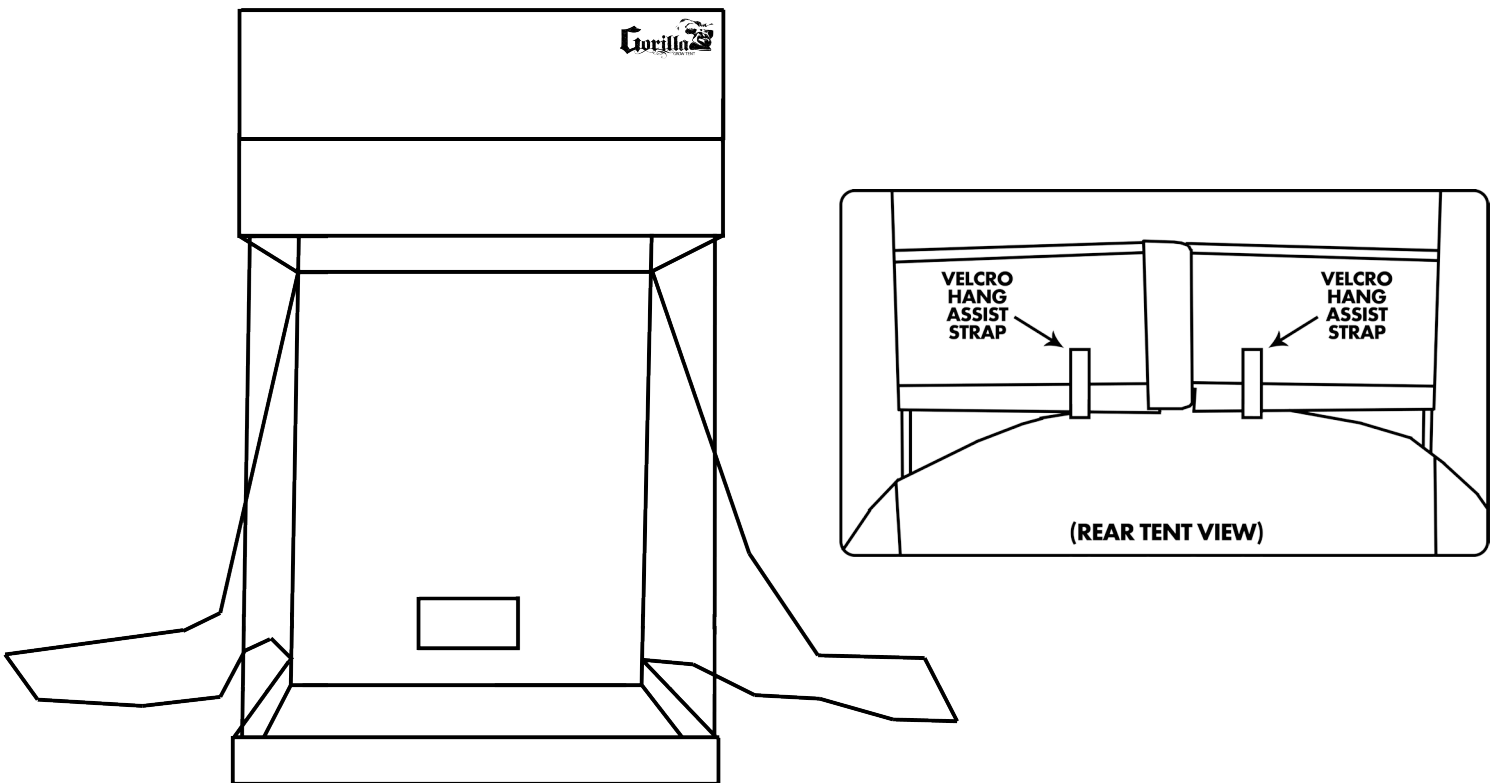

# 8. Add Roof Support Beams & Install Spill Pool

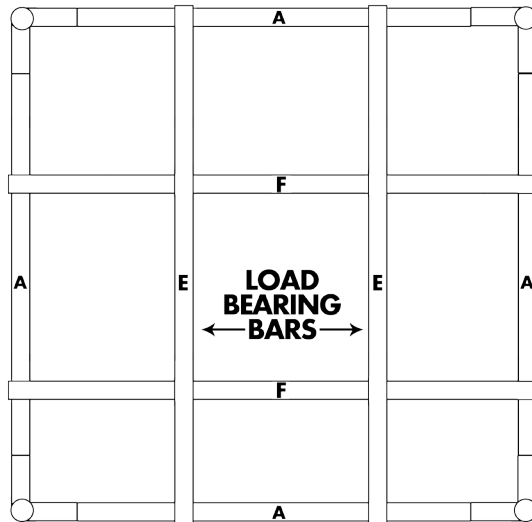
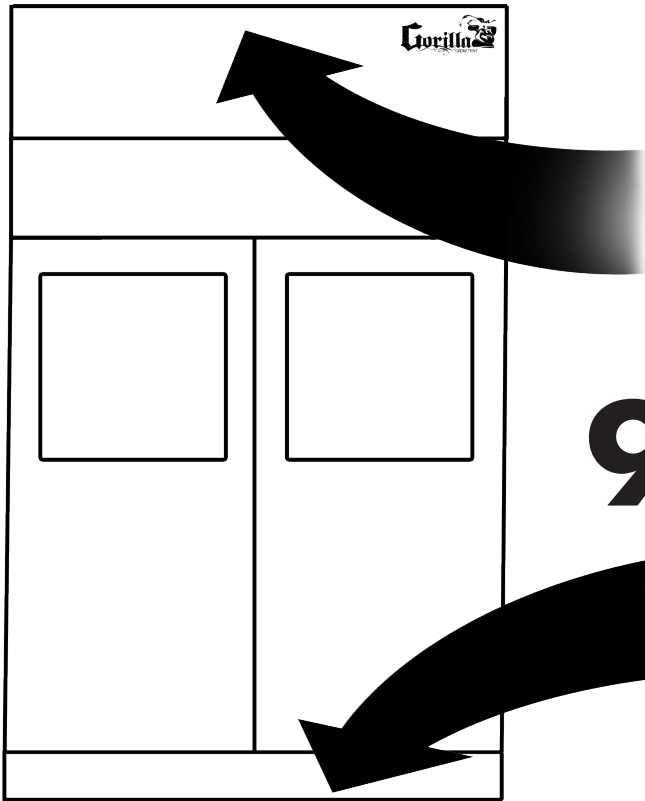

# 9. Place spill pool on floor of tent and secure Velcro straps around poles.

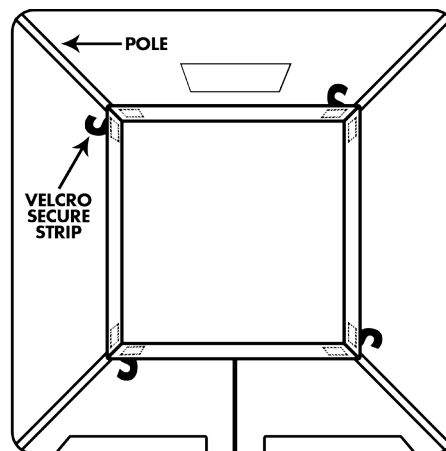

**TALLEST. THICKEST. STRONGEST.**

WWW.GORILLAGROWTENT.COM 1-855-G<sub>4</sub>G<sub>4</sub>T<sub>8</sub>-G<sub>4</sub>R<sub>7</sub>O<sub>6</sub>W<sub>9</sub>